

RTS Automatic Transfer Switch

TECHNICAL MANUAL

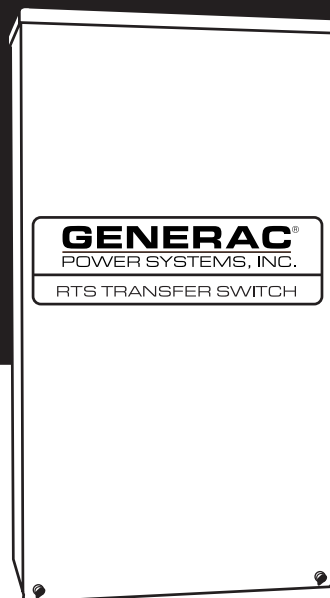

A new standard of reliability

GENERAC®
POWER SYSTEMS, INC.



SAVE THESE INSTRUCTIONS! Read the following information carefully before attempting to install, operate or service this equipment. Also read the instructions and information on tags, decals, and labels that may be affixed to the transfer switch. Replace any decal or label that is no longer legible.

DANGER! Connection of a generator to an electrical system normally supplied by an electric utility shall be by means of suitable transfer equipment so as to isolate the electric system from utility distribution system when the generator is operating (Article 701 Legally Required Standby Systems or Article 702 Optional Standby Systems, as applicable). Failure to isolate electric system by these means may result in damage to generator and may result in injury or death to utility workers due to backfeed of electrical energy.

Generac Power Systems, Inc., hereafter referred to as the “manufacturer”, cannot anticipate every possible circumstance that might involve a hazard. The warnings in this manual, and on tags and decals affixed to the unit are, therefore, not all-inclusive. If using a procedure, work method or operating technique the manufacturer does not specifically recommend, ensure that it is safe for others. Also make sure the procedure, work method or operating technique chosen does not render the transfer switch unsafe.

Throughout this publication, and on tags and decals affixed to the generator, DANGER, WARNING, CAUTION and NOTE blocks are used to alert personnel to special instructions about a particular operation that may be hazardous if performed incorrectly or carelessly. Observe them carefully. Their definitions are as follows:

—  **DANGER**  —

After this heading, read instructions that, if not strictly complied with, will result in personal injury, including death, or property damage.

—  **WARNING**  —

After this heading, read instructions that, if not strictly complied with, may result in personal injury or property damage.

—  **CAUTION**  —





After this heading, read instructions that, if not strictly complied with, could result in damage to equipment and/or property.

NOTE:

After this heading, read explanatory statements that require special emphasis.

These safety warnings cannot eliminate the hazards that they indicate. Common sense and strict compliance with the special instructions while performing the service are essential to preventing accidents.

Four commonly used safety symbols accompany the DANGER, WARNING and CAUTION blocks. The type of information each indicates follows:

-  This symbol points out important safety information that, if not followed, could endanger personal safety and/or property.
-  This symbol points out potential explosion hazard.
-  This symbol points out potential fire hazard.
-  This symbol points out potential electrical shock hazard.

GENERAL HAZARDS

- Any AC generator that is used for backup power if a NORMAL (UTILITY) power source failure occurs, must be isolated from the NORMAL (UTILITY) power source by means of an approved transfer switch. Failure to properly isolate the NORMAL and STANDBY power sources from each other may result in injury or death to electric utility workers, due to backfeed of electrical energy.
- Improper or unauthorized installation, operation, service or repair of the equipment is extremely dangerous and may result in death, serious personal injury, or damage to equipment and/or personal property.
- Extremely high and dangerous power voltages are present inside an installed transfer switch. Any contact with high voltage terminals, contacts or wires will result in extremely hazardous, and possibly LETHAL, electric shock. DO NOT WORK ON THE TRANSFER SWITCH UNTIL ALL POWER VOLTAGE SUPPLIES TO THE SWITCH HAVE BEEN POSITIVELY TURNED OFF.
- Competent, qualified personnel should install, operate and service this equipment. Adhere strictly to local, state and national electrical and building codes. When using this equipment, comply with regulations the National Electrical Code (NEC), CSA Standard; C22.1 Canadian Electric Code and Occupational Safety and Health Administration (OSHA) have established.
- Never handle any kind of electrical device while standing in water, while barefoot, or while hands or feet are wet. DANGEROUS ELECTRICAL SHOCK MAY RESULT.

- Remove all jewelry (such as rings, watches, bracelets, etc.) before working on this equipment.
- If work must be done on this equipment while standing on metal or concrete, place insulative mats over a dry wood platform. Work on this equipment only while standing on such insulative mats.
- Never work on this equipment while physically or mentally fatigued.
- Keep the transfer switch enclosure door closed and bolted at all times. Only qualified personnel should be permitted access to the switch interior.
- In case of an accident caused by electric shock, immediately shut down the source of electrical power. If this is not possible, attempt to free the victim from the live conductor but **AVOID DIRECT CONTACT WITH THE VICTIM**. Use a nonconducting implement, such as a dry rope or board, to free the victim from the live conductor. If the victim is unconscious, apply first aid and get immediate medical help.
- When an automatic transfer switch is installed for a standby generator set, the generator engine may crank and start at any time without warning. To avoid possible injury that might be caused by such sudden start-ups, the system's automatic start circuit must be disabled before working on or around the generator or transfer switch. Then place a "DO NOT OPERATE" tag on the transfer switch and on the generator. Remove the Negative (Neg) or (-) battery cable.

Safety Rules.....Inside Front Cover

Section 1 – General Information2

1.1 Introduction2

1.2 Equipment Description2

1.3 Transfer Switch Data Decal.....2

1.4 Transfer Switch Enclosure2

1.5 Safe Use Of Transfer Switch2

Section 2 – Installation3

2.1 Introduction to Installation3

2.2 Unpacking3

2.3 Mounting3

2.4 Connecting Power Source and Load Lines.....3

 2.4.1 2-Pole Mechanism3

2.5 Connecting Start Circuit Wires4

Section 3 – Operation4

3.1 Functional Tests & Adjustments4

3.2 Manual Operation4

 3.2.1 Close to Normal Source Side4

 3.2.2 Close to Emergency Source Side.....5

 3.2.3 Return to Normal Source Side5

3.3 Voltage Checks.....5

3.4 Generator Tests Under Load6

Section 4 – Notes.....7

Section 5 – Installation Diagram.....10

Section 6 – Electrical Data11

Section 7 – Exploded Views & Parts Lists14

Section 8 – Warranty/Service.....Back Cover

<p>For authorized service, reference the dealer locator number found inside the generator owner's manual.</p>
--

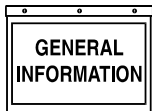

Section 1 – General Information

RTS "HS" Type Transfer Switch

1.1 INTRODUCTION

This manual has been prepared especially for the purpose of familiarizing personnel with the design, application, installation, operation and servicing of the applicable equipment. Read the manual carefully and comply with all instructions. This will help to prevent accidents or damage to equipment that might otherwise be caused by carelessness, incorrect application, or improper procedures.

Every effort has been expended to make sure that the contents of this manual are both accurate and current. The manufacturer, however, reserves the right to change, alter or otherwise improve the product at any time without prior notice.

1.2 EQUIPMENT DESCRIPTION

The automatic transfer switch is used for transferring electrical load from a UTILITY (NORMAL) power source to a EMERGENCY (STANDBY) power source. Such a transfer of electrical loads occurs automatically when the UTILITY power source has failed or is substantially reduced and the EMERGENCY source voltage and frequency have reached an acceptable level. The transfer switch prevents electrical feedback between two different power sources (such as the UTILITY and EMERGENCY sources) and, for that reason, codes require it in all standby electric system installations.

The transfer switch consists of a transfer mechanism, a relay control, and a terminal strip for connection of sensing wires.

This switch is suitable for control of motors, electric discharge lamps, tungsten filament and electric heating equipment and the tungsten load does not exceed 30% of the switch rating.

The transfer switch is for use in optional standby systems only.

A 100A rated switch is suitable for use on circuits capable of delivering not more than 10,000 RMS symmetrical amperes, 250 VAC maximum, when protected by a 100A maximum circuit breaker (Siemens types QP or BQ) or 150A maximum circuit breaker (Square D Q2, Westinghouse CA-CAH, General Electric TQ2 and Siemens QJ2).

A 200A rated switch is suitable for use on a circuit capable of 10,000 rms symmetrical amperes, 240 VAC when protected by a circuit breaker without an adjustable short time response or by fuses.

1.3 TRANSFER SWITCH DATA DECAL

A DATA DECAL is permanently affixed to the transfer switch enclosure. Use this transfer switch only within the specific limits shown on the DATA DECAL and on other decals and labels that may be affixed to the switch. This will prevent damage to equipment and property.

When requesting information or ordering parts for this equipment, make sure to include all information from the DATA DECAL.

Record the Model and Serial numbers in the space provided below for future reference.

MODEL #
SERIAL #

1.4 TRANSFER SWITCH ENCLOSURE

The standard switch enclosure is a National Electrical Manufacturer's Association (NEMA) 3R type. NEMA 3R type enclosures primarily provide a degree of protection against falling rain and sleet and is not damaged by the formation of ice on the enclosure.

1.5 SAFE USE OF TRANSFER SWITCH

Before installing, operating or servicing this equipment, read the SAFETY RULES (inside front cover) carefully. Comply strictly with all SAFETY RULES to prevent accidents and/or damage to the equipment. The manufacturer recommends that a copy of the SAFETY RULES are posted near the transfer switch. Also, be sure to read all instructions and information found on tags, labels and decals affixed to the equipment.

Two publications that outline the safe use of transfer switches are the following:

- NFPA 70; National Electrical Code
- UL 1008, STANDARD FOR SAFETY-AUTOMATIC TRANSFER SWITCHES

NOTE:

It is essential to use the latest version of any standard to ensure correct and current information.

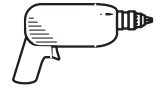

2.1 INTRODUCTION TO INSTALLATION

This equipment has been wired and tested at the factory. Installing the switch includes the following procedures:

- Mounting the enclosure.
- Connecting power source and load leads.
- Connecting the generator start and sensing circuit.
- Connecting any auxiliary contact (if needed)
- Testing functions.

2.2 UNPACKING

Carefully unpack the transfer switch. Inspect closely for any damage that might have occurred during shipment. The purchaser must file with the carrier any claims for loss or damage incurred while in transit.

Check that all packing material is completely removed from the switch prior to installation.

2.3 MOUNTING

Mounting dimensions for the transfer switch enclosure are in this manual. Enclosures are typically wall-mounted. See “Installation Diagram”, Section 5.



- Handle transfer switches carefully when installing. Do not drop the switch. Protect the switch against impact at all times, and against construction grit and metal chips. Never install a transfer switch that has been damaged.

Install the transfer switch as close as possible to the electrical loads that are to be connected to it. Mount the switch vertically to a rigid supporting structure. To prevent switch distortion, level all mounting points. If necessary, use washers behind mounting holes to level the unit.

2.4 CONNECTING POWER SOURCE AND LOAD LINES



- Make sure to turn OFF both the UTILITY (NORMAL) and EMERGENCY (STANDBY) power supplies before trying to connect power source and load lines to the transfer switch. Supply voltages are extremely high and dangerous. Contact with such high voltage power supply lines will result in an extremely hazardous, possibly lethal, electrical shock.

Wiring diagrams and electrical schematics are provided in this manual. Power source and load connections are made at a transfer mechanism, inside the switch enclosure.

2.4.1 2-POLE MECHANISM

These switches (Figure 2.1) are used with a single-phase system, when the single-phase NEUTRAL line is to be connected to a Neutral Lug and is not to be switched.

Figure 2.1 — Typical 2-Pole Transfer Mechanism (200 Amp Shown)

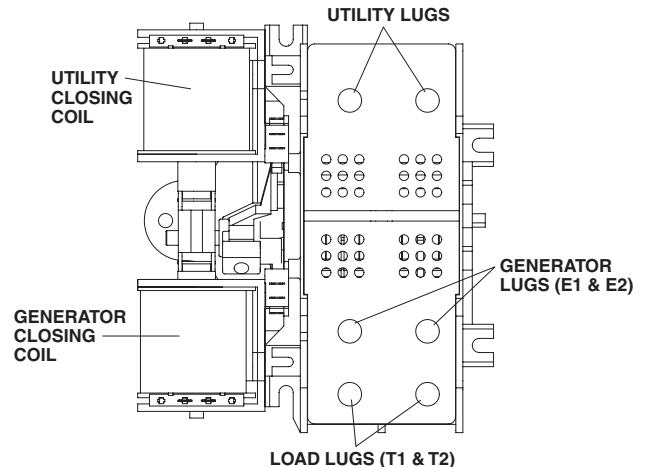

Solderless, screw-type terminal lugs are standard.

Switch Rating	Wire Range	Conductor Tightening Torque
100A	#14-1/0 AWG	50 in-lbs.
200A	#6-250 MCM	275 in-lbs.

Conductor sizes must be adequate to handle the maximum current to which they will be subjected to, based on the 75°C column of tables, charts, etc. used to size conductors. The installation must comply fully with all applicable codes, standards and regulations.

Before connecting wiring cables to terminals, remove any surface oxides from the cable ends with a wire brush. All power cables should enter the switch next to transfer mechanism terminals. If ALUMINUM conductors are used, apply corrosion inhibitor to conductors. Tighten terminal lugs to the torque values as noted on the decal located on the inside of the door. After tightening terminal lugs, carefully wipe away any excess corrosion inhibitor.

All power cables should enter the switch next to the transfer mechanism terminals.



- Use a torque wrench to tighten the conductors, being sure not to over tighten, or damage to the switch base could occur. If not tightened enough, a loose connection would result, causing excess heat which could damage the switch base.

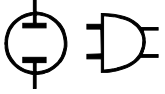

Connect power source load conductors to clearly marked transfer mechanism terminal lugs as follows

1. Connect UTILITY (NORMAL) power source cables to switch terminals N1, N2.
2. Connect EMERGENCY (STANDBY) source power cables to transfer switch terminals E1, E2.
3. Connect customer LOAD leads to switch terminals T1, T2.

Conductors must be properly supported, of approved insulative qualities, protected by approved conduit, and of the correct wire gauge size in accordance with applicable codes.

Be sure to maintain proper electrical clearance between live metal parts and grounded metal. Allow at least 1/2 inch for 100-400 amp circuits.

2.5 CONNECTING START CIRCUIT WIRES

Control system interconnections (Section 6) consist of UTILITY 1 (N1) and UTILITY 2 (N2), and leads 23 and 194. Recommended wire gauge sizes for this wiring depends on the length of the wire, as recommended below:

MAXIMUM WIRE LENGTH	RECOMMENDED WIRE SIZE
460 feet (140m)	No. 18 AWG.
461 to 730 feet (223m)	No. 16 AWG.
731 to 1,160 feet (354m)	No. 14 AWG.
1,161 to 1,850 feet (565m)	No. 12 AWG.

3.1 FUNCTIONAL TESTS AND ADJUSTMENTS

Following transfer switch installation and interconnection, inspect the entire installation carefully. A competent, qualified electrician should inspect it. The installation should comply strictly with all applicable codes, standards, and regulations. When absolutely certain the installation is proper and correct, complete a functional test of the system.



Perform functional tests in the exact order presented in this manual, or damage could be done to the switch.

IMPORTANT: Before proceeding with functional tests, read and make sure all instructions and information in this section are understood. Also read the information and instructions of labels and decals affixed to the switch. Note any options or accessories that might be installed and review their operation.

3.2 MANUAL OPERATION



Do NOT manually transfer under load. Disconnect transfer switch from all power sources by approved means, such as a main circuit breaker(s).

A manual HANDLE is shipped with the transfer switch. Manual operation must be checked BEFORE the transfer switch is operated electrically. To check manual operation, proceed as follows:

1. Turn the generator's AUTO-OFF-MANUAL switch to OFF.
2. Turn OFF both UTILITY and EMERGENCY power supplies to the transfer switch, with whatever means provided (such as the main line circuit breakers).
3. Note position of transfer mechanism main contacts by observing the moveable contact carrier arm.
 - Manual operation handle towards the top of switch mechanism - LOAD terminals (T1, T2) are connected to UTILITY terminals (N1, N2).
 - Manual operation handle towards the bottom of switch mechanism - LOAD terminals (T1, T2) are connected to EMERGENCY terminals (E1, E2).



Do not use excessive force when operating the transfer switch manually or damage could be done to the manual handle.

◆ 3.2.1 CLOSE TO NORMAL SOURCE SIDE

Before proceeding, verify the position of the switch by observing the position of manual operation handle in Figure 3.1. If the handle is UP, the contacts are closed in the NORMAL position, no further action is required. If the handle is DOWN, proceed with Step 1.

Step 1: With the handle inserted into the actuating shaft, move handle UP. Be sure to hold on to the handle as it will move quickly after the center of travel.

Figure 3.1 — Actuating Transfer Switch

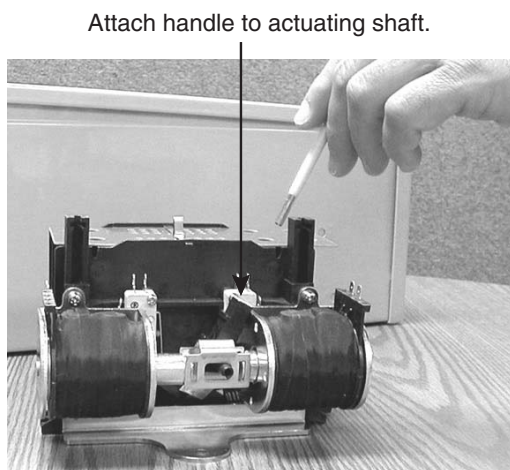

NOTE: Return handle to storage position in enclosure when finished with manual transfer.

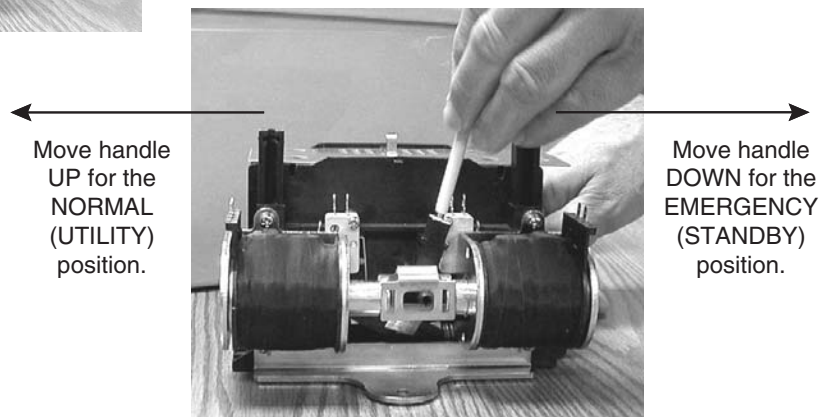

◆ 3.2.2 CLOSE TO EMERGENCY SOURCE SIDE

Before proceeding, verify the position of the switch by observing the position of the manual operation handle in Figure 3.1. If the handle is DOWN, the contacts are closed in the EMERGENCY (STANDBY) position. No further action is required. If the handle is UP, proceed with Step 1.

Step 1: With the handle inserted into the actuating shaft, move the handle DOWN. Be sure to hold on to the handle as it will move quickly after the center of travel.

◆ 3.2.3 RETURN TO NORMAL SOURCE SIDE

Manually actuate switch to return manual operating handle to the UP position.

3.3 VOLTAGE CHECKS

1. Turn ON the UTILITY power supply to the transfer switch with whatever means provided (such as the UTILITY main line circuit breaker).

—▲ DANGER ▲—

▲ PROCEED WITH CAUTION. THE TRANSFER SWITCH IS NOW ELECTRICALLY HOT. CONTACT WITH LIVE TERMINALS RESULTS IN EXTREMELY HAZARDOUS AND POSSIBLY FATAL ELECTRICAL SHOCK.

2. With an accurate AC voltmeter, check for correct voltage.

Single-phase utility supply:

Measure across ATS terminal lugs N1 and N2. Also check N1 to NEUTRAL and N2 to NEUTRAL.

3. When certain that UTILITY supply voltage is correct and compatible with transfer switch ratings, turn OFF the UTILITY supply to the transfer switch.

4. On the generator panel, set the AUTO-OFF-MANUAL switch to MANUAL position. The generator should crank and start.

5. Let the generator stabilize and warm up at no-load for at least five minutes.

6. Set the generator's main circuit breaker (CB1) to its ON or CLOSED position.

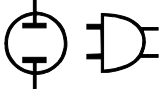

PROCEED WITH CAUTION. GENERATOR OUTPUT VOLTAGE IS NOW BEING DELIVERED TO TRANSFER SWITCH TERMINALS. CONTACT WITH LIVE TERMINALS RESULTS IN EXTREMELY DANGEROUS AND POSSIBLY FATAL ELECTRICAL SHOCK.

7. With an accurate AC voltmeter and frequency meter, check the no-load, voltage and frequency.

Single-phase generator supply:

Measure across ATS terminal lugs E1 to E2. Also check E1 to NEUTRAL and E2 to NEUTRAL.

- a. Frequency60-62 Hertz
 - b. Terminals E1 to E2240-246 VAC
 - c. Terminals E1 to NEUTRAL120-123 VAC
 - d. Terminals E2 to NEUTRAL120-123 VAC
8. Set the generator's main circuit breaker (CB1) to its OFF or OPEN position.
 9. Set the AUTO/OFF/MANUAL switch to the OFF position to shut down the generator.

NOTE:

Do NOT proceed until generator AC output voltage and frequency are correct and within stated limits. If the no-load voltage is correct but no-load frequency is incorrect, the engine governed speed probably requires adjustment. If no-load frequency is correct but voltage is not, the voltage regulator may require adjustment.

3.4 GENERATOR TESTS UNDER LOAD

1. Set the generator's main circuit breaker to its OFF or OPEN position.
2. Manually actuate the transfer switch main contacts to their EMERGENCY (STANDBY) position. Refer to Manual Operation (Section 3.2).
3. To start the generator, set the AUTO-OFF-MANUAL switch to MANUAL. When engine starts, let it stabilize for a few minutes.
4. Turn the generator's main circuit breaker to its ON or CLOSED position. The generator now powers all LOAD circuits. Check generator operation under load as follows:
 - Turn ON electrical loads to the full rated wattage/ampere capacity of the generator. DO NOT OVERLOAD.
 - With maximum rated load applied, check voltage and frequency across transfer switch terminals E1 and E2. Voltage should be greater than 230 volts and frequency should be greater than 59 Hertz.
 - Let the generator run under rated load for at least 30 minutes. With unit running, listen for unusual noises, vibration, overheating, etc., that might indicate a problem.
5. When checkout under load is complete, set main circuit breaker of the generator to its OFF or OPEN position.
6. Let the generator run at no-load for several minutes. Then, shut down by setting the AUTO-OFF-MANUAL switch to its OFF position.
7. Move the switch's main contacts back to their UTILITY position. For example, load connected to UTILITY power supply. Refer to Manual Operation (Section 3.2). Handle and operating lever of transfer switch should be in UP position.
8. Turn on the UTILITY power supply to transfer switch, using whatever means provided (such as a UTILITY main line circuit breaker). The UTILITY power source now powers the loads.
9. Set the generator's AUTO-OFF-MANUAL switch to its AUTO position. The system is now set for fully automatic operation.

Section 4 – Notes
RTS "HS" Type Transfer Switch

NOTES

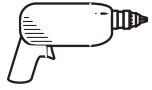

Section 5 – Installation Diagram

RTS "HS" Type Transfer Switch

Drawing No. 0E7081

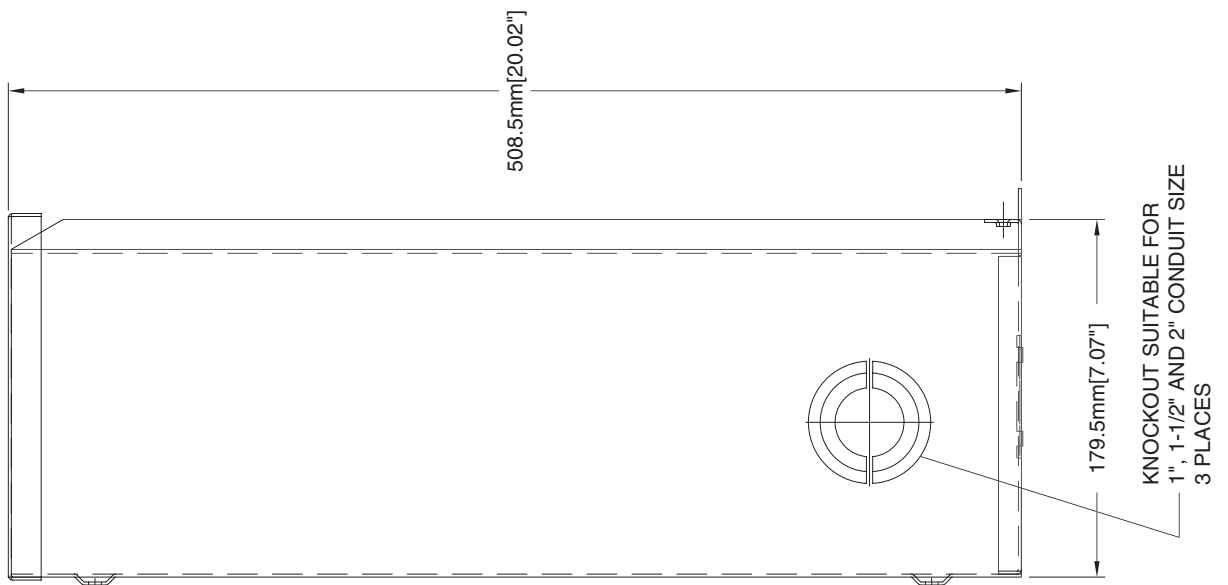
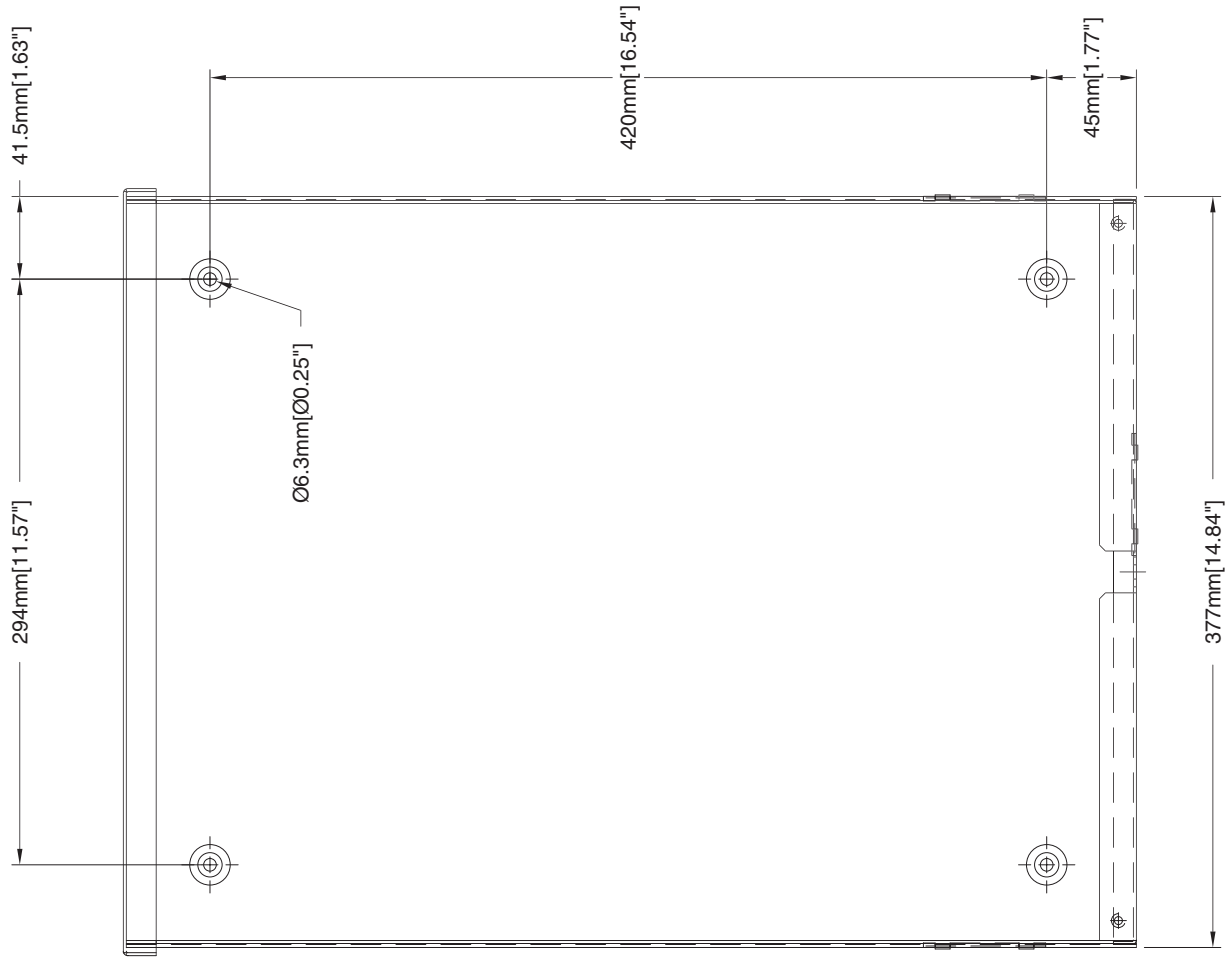

Section 6 – Electrical Data
RTS "HS" Type Transfer Switch
Transfer Switch Interconnections - Drawing No. 0F6941

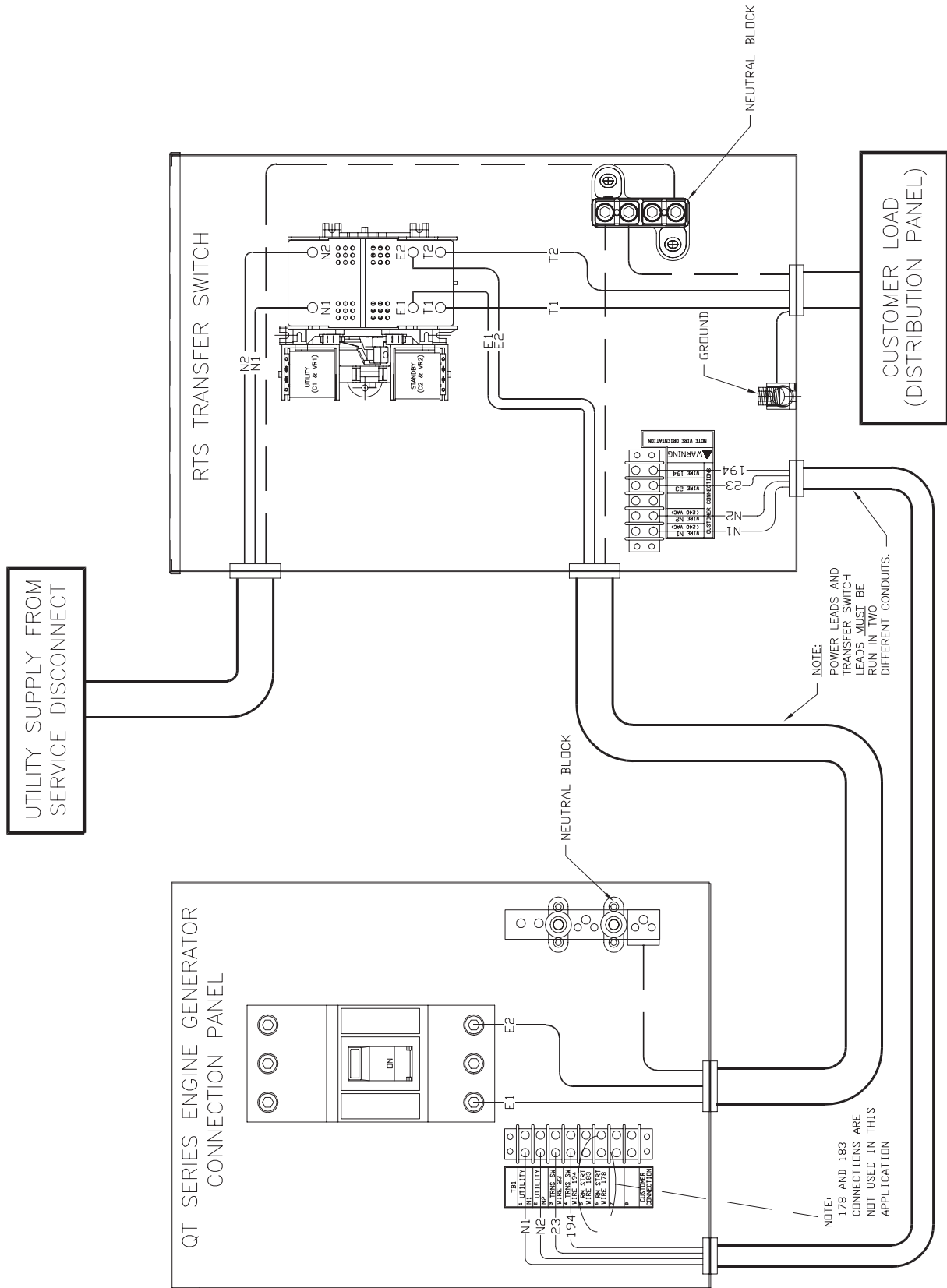
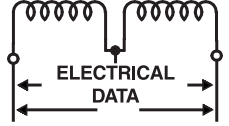

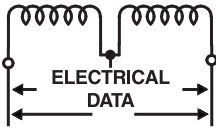

Section 6 – Electrical Data

RTS "HS" Type Transfer Switch

Electrical Schematic - Drawing No. 0F6768

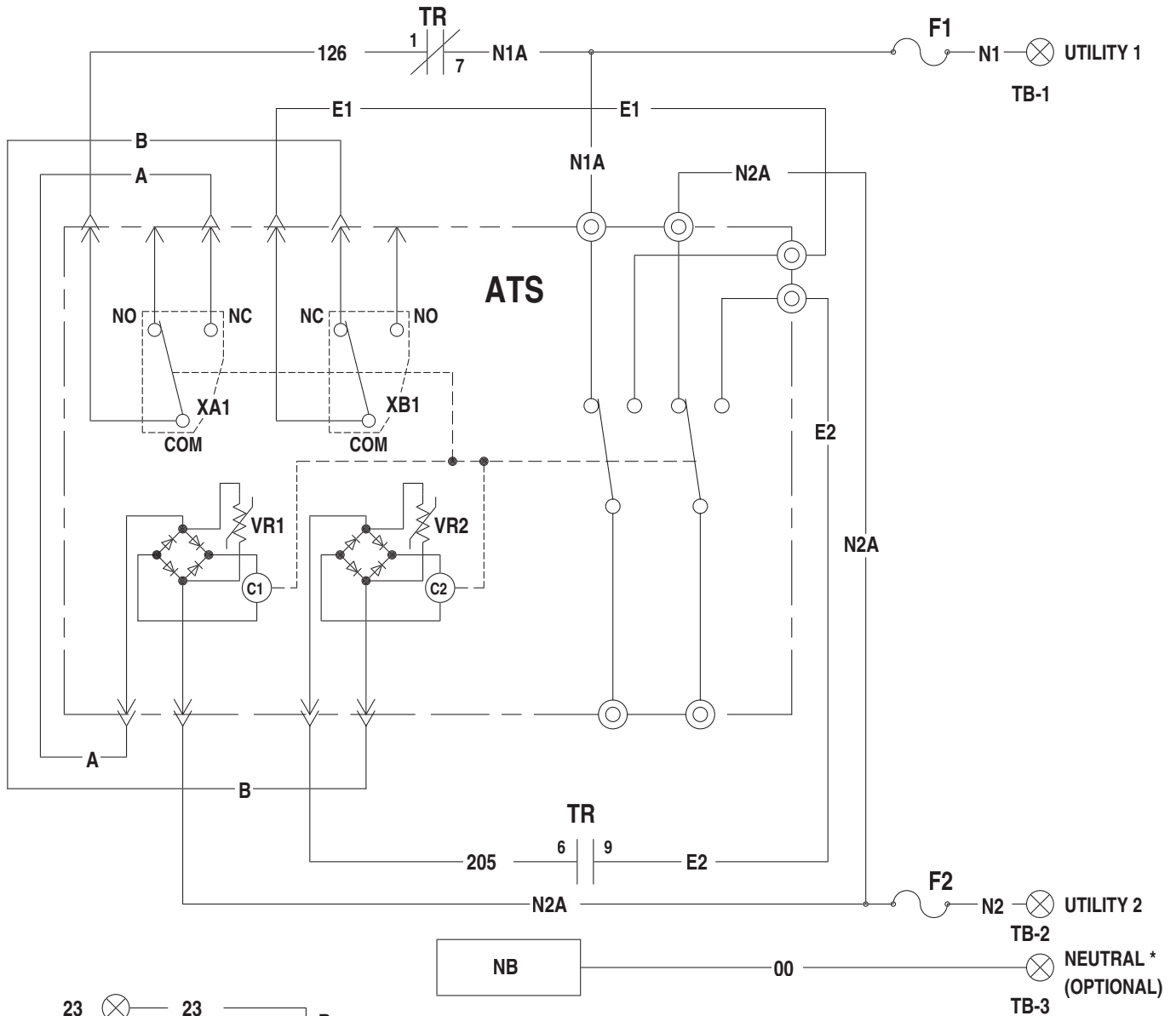

* - NOT USED WITH PREPACKAGED STANDBY GENERATORS

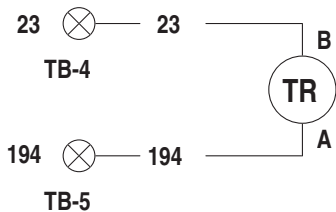

NOTE:
ALL CONTACTS SHOWN WITH
TRANSFER SWITCH IN UTILITY
POSITION.

LEGEND	
ATS	TRANSFER SWITCH CONTACTOR
C1	SOLENOID COIL (UTILITY CLOSING)
C2	SOLENOID COIL (STANDBY CLOSING)
TR	RELAY, TRANSFER
TB	TERMINAL STRIP (CUSTOMER CONNECTION)
XA1,XB1	LIMIT SWITCHES, ACTUATOR
F1,F2	FUSE, 5A
VR1,VR2	VARISTOR
NB	NB - NEUTRAL BLOCK

Section 6 – Electrical Data
RTS "HS" Type Transfer Switch
Electrical Schematic - Drawing No. 0F6768

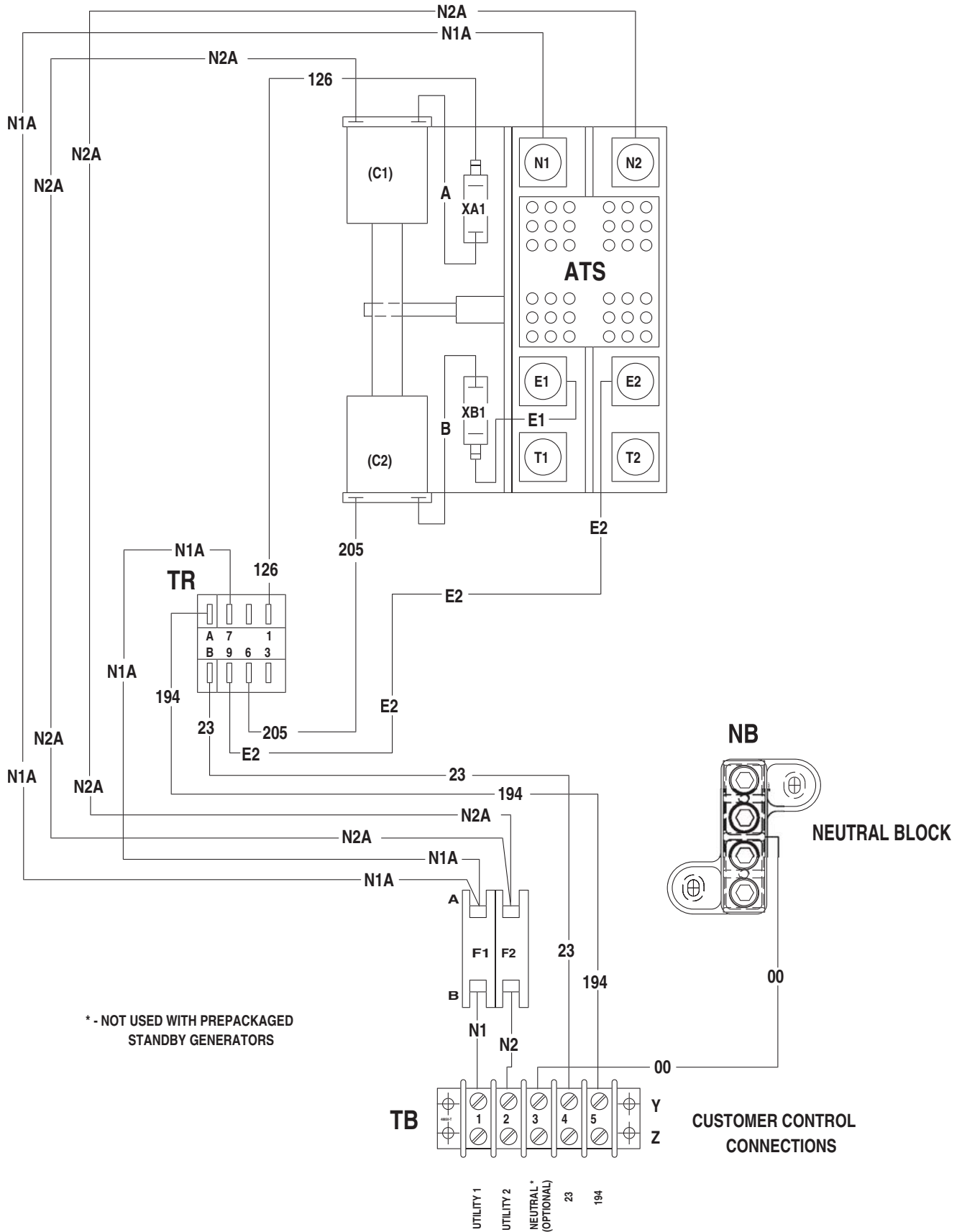
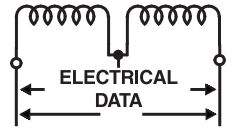

Section 7 – Exploded Views and Parts List

RTS "HS" Type Transfer Switch

100A Transfer Switch Assembly – Drawing No. 0F6766\$

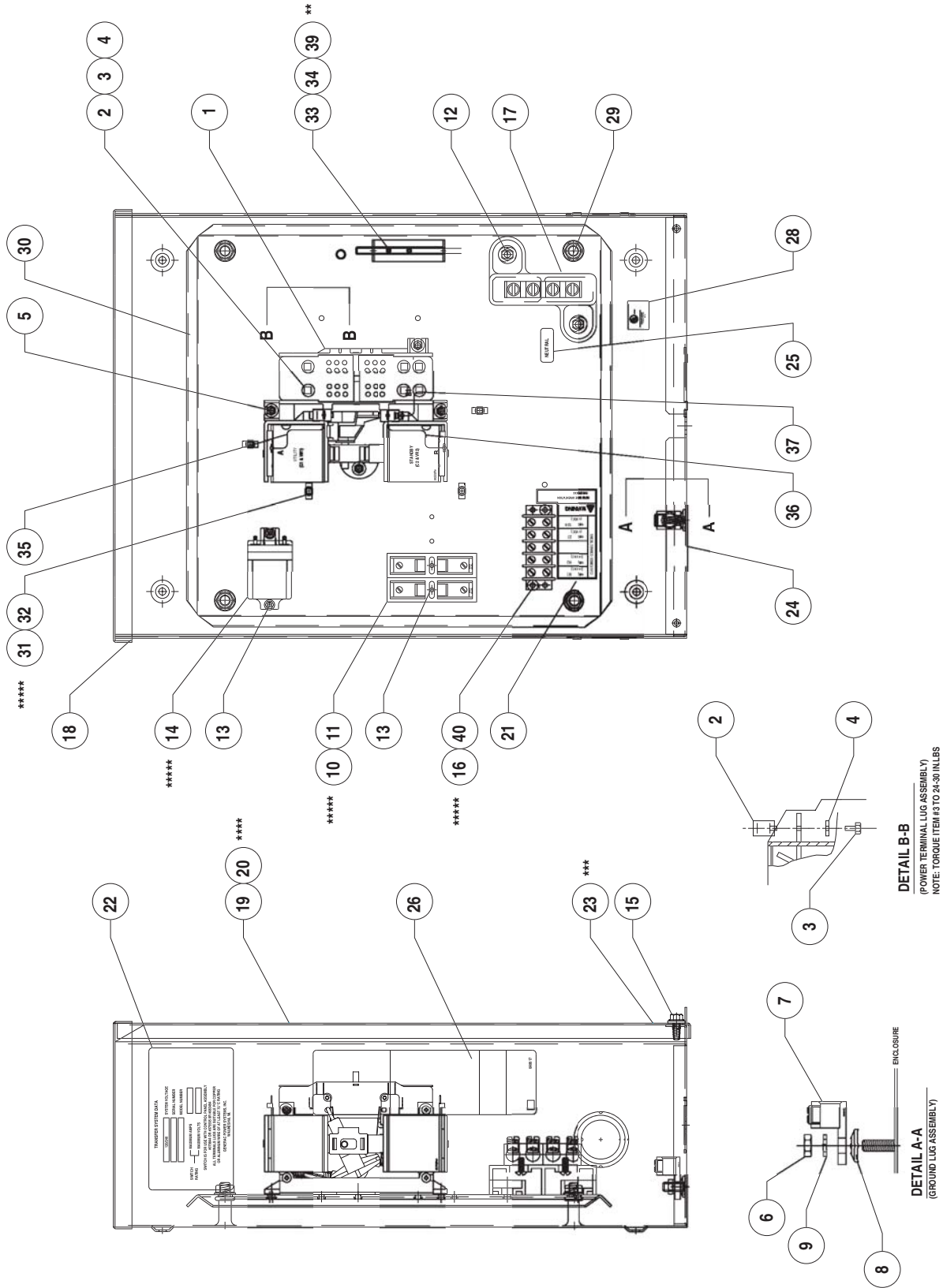

Section 7 – Exploded Views and Parts List

RTS "HS" Type Transfer Switch

100A Transfer Switch Assembly – Drawing No. 0F6766\$

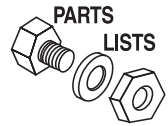

ITEM	PART NO.	QTY.	DESCRIPTION
1	0C2237	1	TR SW-HSB 100A 2P 250V
2	077033	6	LUG SLDLSS 1/0-#14X9/16 AL/CU
3	036932	6	SCREW PPHM #10-32 X 1/4
4	022152	6	WASHER LOCK #10
5	074908	4	SCREW HHTT M5-0.8 X 10 BP
6	045771	1	NUT HEX M8-1.25 G8 YEL CHR
7	062684	1	LUG SLDLSS 2/0-#12 X 11/32 CU
8	0C3168	1	WASHER LOCK SPECIAL 5/16
9	022129	1	WASHER LOCK M8-5/16
10	073590A	2	FUSE 5A X BUSS
11*****	073591	2	FUSE HOLDER
12	090388	2	SCREW HHTT M6-1.0 X 12 ZINC
13	0A1495	4	SCREW HHTT M4-0.7 X 10 BP
14*****	063617	1	RELAY PNL 12VDC DPDT 10A@240VA
15	0C2454	2	SCREW TH-FRM M6-1 X 16 N WA ZJS
16	0A1661	2	RIVET POP .156 X .675 AL
17	0C4449	1	ASSY NEUTRAL BLOCK 100A
18	0E6057	1	WELDMENT XFER SW BOX HSB
19	0E6056	1	COVER TRANSFER SWITCH BOX HSB
20****	0F6521	1	DECAL TRANSFER SWITCH RTS (NOT SHOWN)
21	0C2262	1	DECAL TERMINAL STRIP
22	0E8443	1	DECAL SWITCH RATING
23***	095282	1	DECAL-LIVE CIRCUIT
24	067210A	1	DECAL GROUND LUG
25	0A9457	1	DECAL NEUTRAL
26	0A9517	1	DECAL MANUAL 5A FUSE
27*	077036D	1	DECAL TEST SEQUENCE 3R (NOT SHOWN)
28	081221	1	DECAL-UL LIST HSB
29	064101	4	NUT HEX FL WHIZ 3/8-16
30	0E6055	1	SUBPLT TRANSFER SWITCH HSB
31*****	063378	4	HOLDER CABLE TIE
32*****	028739	4	TIE WRAP UL 3.9" X .10" NATL
33	0E6193	1	BRACKET, ARM EXTENDER
34**	0E6155	0	ARM EXTENDER PIN
35	0E6303	1	WIRE A
36	0E6303A	1	WIRE B
37	0E6303C	1	WIRE E1
38	0F6767	1	HARNNESS 100/200 2P RTS (NOT SHOWN)
39	064526	2	SCREW HWHS #6-25 X 3/8 ZNC
40*****	048850	1	BLOCK TERM 20A 5 X 6 X 1100V

* CENTER DECAL ON INSIDE OF THE COVER (ITEM #19)

** SUPPLIED WITH TRANSFER SWITCH ITEM #1.

*** PLACE DECAL ON OUTSIDE OF COVER, LOWER RIGHT CORNER.

**** NOT SHOWN ON THIS ASSEMBLY, CENTER DECAL ON FRONT OF COVER, 7" FROM TOP OF ENCLOSURE.

***** SUPPLIED WITH HARNNESS (P/N 0F6767)

Section 7 – Exploded Views and Parts List

RTS "HS" Type Transfer Switch

200A Transfer Switch Assembly – Drawing No. 0F6769\$

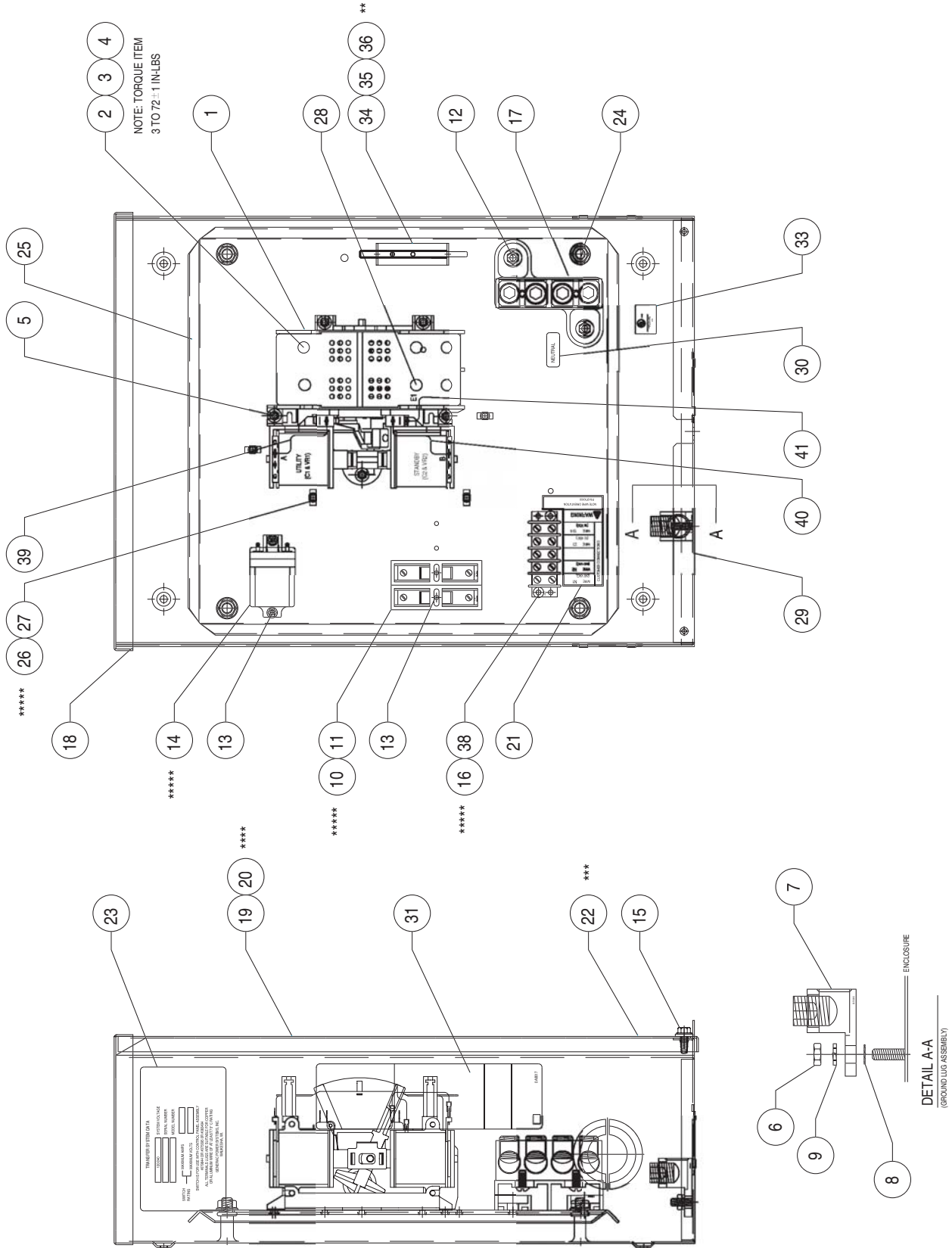

Section 7 – Exploded Views and Parts List

RTS "HS" Type Transfer Switch

200A Transfer Switch Assembly – Drawing No. 0F6769\$

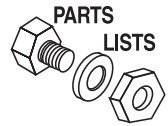

ITEM	PART NO.	QTY.	DESCRIPTION
1	0D9618	1	TR SW-HSB 200A 2P 250V
2	0E3375	6	LUG SLDLSS 250-#6 AL/CU
3	0F1252	6	SCREW BHSC 1/4-20 X 3/8
4	022097	6	WASHER LOCK M6-1/4
5	074908	5	SCREW HHTT M5-0.8 X 10 BP
6	045771	1	NUT HEX M8-1.25 G8 YEL CHR
7	057329	1	LUG SLDLSS 350-#6 X 13/32 AL/CU
8	027482	1	WASHER SHAKEPROOF EXT 5/16 STL
9	022129	1	WASHER LOCK M8-5/16
10	073590A	2	FUSE 5A X BUSS
11*****	073591	2	FUSE HOLDER
12	090388	2	SCREW HHTT M6-1.0 X 12 ZINC
13	0A1495	4	SCREW HHTT M4-0.7 X 10 BP
14*****	063617	1	RELAY PNL 12VDC DPDT 10A@240VA
15	0C2454	2	SCREW TH-FRM M6-1 X 16 N WA ZJS
16	0A1661	2	RIVET POP .156 X .675 AL
17	0C4449A	1	ASS'Y-NTRL BL150-200A
18	0E6057	1	WELDMENT XFER SW BOX HSB
19	0E6056	1	COVER TRANSFER SWITCH BOX HSB
20****	0F6521	1	DECAL TRANSFER SWITCH RTS (NOT SHOWN)
21	0C2262	1	DECAL TERMINAL STRIP
22***	095282	1	DECAL-LIVE CIRCUIT
23	0E8443	1	DECAL SWITCH RATING
24	064101	4	NUT LOCK FL 3/8-16
25	0E6055	1	SUBPLT TRANSFER SWITCH HSB
26*****	063378	5	HOLDER CABLE TIE
27*****	028739	5	TIE WRAP UL 3.9" X .10" NATL
28 **	0E6033	1	90 DEGREE DN SPADE CONNECTOR
29	067210A	1	DECAL GROUND LUG
30	0A9457	1	DECAL NEUTRAL
31	0A9517	1	DECAL MANUAL 5A FUSE
32 *	0E6190	1	DECAL TEST SEQUENCE 2P TS 3R (NOT SHOWN)
33	081221	1	DECAL-UL LIST HSB
34	0E6193	1	BRACKET ARM EXTENDER
35	064526	2	SCREW HWHS #6-25 X 3/8 ZNC
36 **	0E6155	1	ARM EXTENDER PIN
37	0F6767	1	HARNES 100/200 2P RTS (NOT SHOWN)
38*****	048850	1	BLOCK TERM 20A 5 X 6 X 1100V
39	0E6303	1	WIRE A
40	0E6303A	1	WIRE B
41	0E6303B	1	WIRE E1

* CENTER DECAL ON INSIDE OF THE COVER (ITEM #19)

** SUPPLIED WITH TRANSFER SWITCH ITEM #1.

*** PLACE DECAL ON OUTSIDE OF COVER, LOWER RIGHT CORNER.

**** NOT SHOWN ON THIS ASSEMBLY, CENTER DECAL ON FRONT OF COVER, 7" FROM TOP OF ENCLOSURE.

***** SUPPLIED WITH HARNES (P/N 0F6767)



Section 8 – Warranty

RTS "HS" Type Transfer Switch

GENERAC POWER SYSTEMS, INC. WARRANTY/SERVICE

Generac Power Systems, Inc. will warrant from the date of purchase that our transfer switch will be free from defects in material and workmanship for the items and periods set forth in the warranty statement found in the owners manual of the Generac Power Systems Inc. generator that this transfer switch will be utilized with.

Any equipment that the purchaser/owner claims to be defective must be examined by the nearest Generac Authorized Warranty Service Dealer which may be found by visiting our website at www.generac.com or by calling the dealer locator number at 1-800-333-1322. Select the prompt that describes the brand name of the generator.

THIS WARRANTY IS IN PLACE OF ALL OTHER WARRANTIES, EXPRESSED OR IMPLIED, SPECIFICALLY, GENERAC MAKES NO OTHER WARRANTIES AS TO THE MERCHANTABILITY OR FITNESS FOR A PARTICULAR PURPOSE.

Some states do not allow limitations on how long an implied warranty lasts, so the above limitation may not apply to you.

GENERAC'S ONLY LIABILITY SHALL BE THE REPAIR OR REPLACEMENT OF PART(S) AS STATED ABOVE. IN NO EVENT SHALL GENERAC POWER SYSTEMS, INC. BE LIABLE FOR ANY INCIDENTAL, OR CONSEQUENTIAL DAMAGES, EVEN IF SUCH DAMAGES ARE A DIRECT RESULT OF GENERAC'S NEGLIGENCE.

Some states do not allow the exclusion or limitation of incidental or consequential damages, so the above limitations may not apply to you.

This warranty gives you specific legal rights. You also may have other rights that vary from state to state.

GENERAC® POWER SYSTEMS, INC.

P.O. BOX 297 · WHITEWATER, WI 53190